

TROUBLE SHOOTING, MICROMAX AND VVX MOTORS

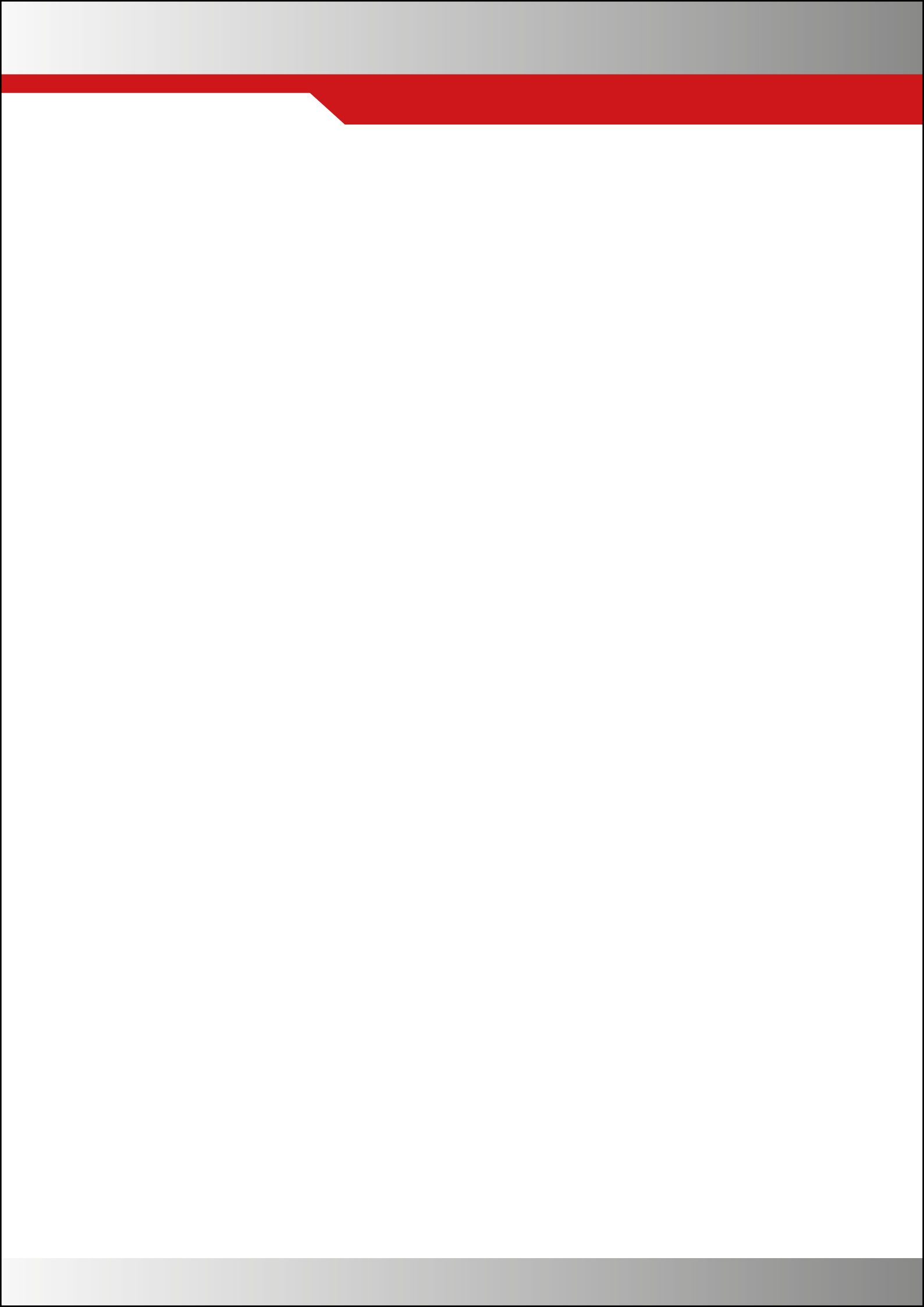
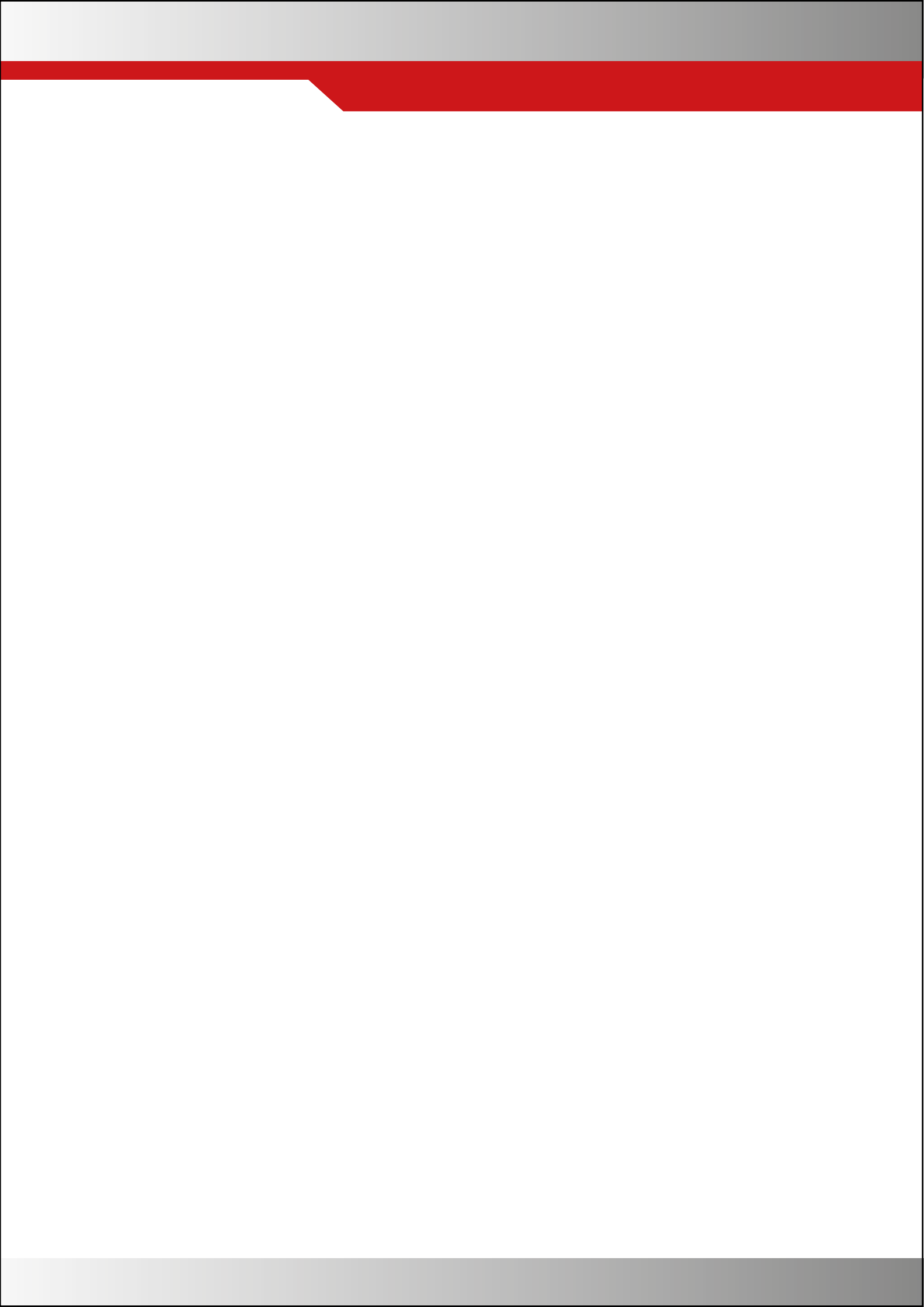

Table of Contents

Page

Troubleshooting, MicroMax, MicroMax180, MicroMax370, MicroMax750

Control unit tripped due to rotation sensor _____	1
Checking the magnetic sensor (applies to IBC's magnetic sensor) _____	1
The motor temperature switch has tripped due to motor winding overheating _____	2
Overvoltage _____	2
Undervoltage _____	2
Overcurrent, Short circuit _____	3
No LED lit _____	4
The wheel rotates despite a 0% input signal from the control unit _____	4
Connecting and troubleshooting VVX motors	
Connecting a three-phase geared motor _____	7
Connecting a three-phase worm gear motor _____	7
Connecting a single-phase worm gear motor _____	8
Connecting a three-phase GEFEG motor _____	8
Measuring motor winding resistance _____	9
Your notes _____	10-11



Troubleshooting, MicroMax, MicroMax180, MicroMax370, MicroMax750

The green ON LED will flash if there is a control unit or motor fault and one or more of the red LEDs will indicate the cause of the fault.

It is important to check which LEDs are showing to make a correct diagnosis.

All alarms remain in state and must not be reset before the above checks are made.

Control unit tripped due to rotation sensor

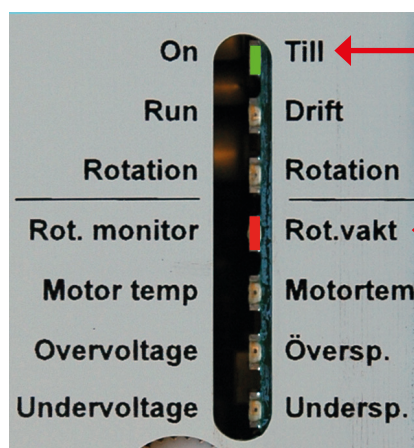

Probable cause during installation:

Magnet facing the wrong way (applies to IBC's magnetic sensor)

Magnetic sensor incorrectly connected (wrong polarity, applies to IBC's magnetic sensor) Connect the white cable to terminal 9, the Brown cable to terminal 10.

Probable cause during operation:

Broken belt

Belt slipping

Stuck wheel

Motor/Gearing damaged.

Checking the magnetic sensor (applies to IBC's magnetic sensor)

Measure the voltage across terminals 9 and 10; the voltage on a non-actuated sensor should be approximately 10 VDC. When the magnet actuates the magnetic sensor, the voltage should be 2.7-3 VDC.

IBC has manufactured three different magnetic sensor series since 1988.

1988 to 23/07/2006

Manufacture of magnetic sensors with voltages of 9.7 V and 2.8-2.9 V.

24/07/2006 to 17/08/2007

Manufacture of 1700 pcs in an ROHS version (lead free) with voltages of 10 V and 2.7 V.

In extreme cold below -25° C, some magnetic sensors may lock up and always show 2.7 V whether the rotation sensor is actuated by the magnet or not.

Note that only 2.7 V magnetic sensors can suffer lock-up in extreme circumstances. These magnetic sensors should be replaced.

As of 18/08/2007

Voltage 10 V or above, or 3 V.

These magnetic sensors do not lock up.

The thermal contact in the motor has tripped due to motor winding overheating

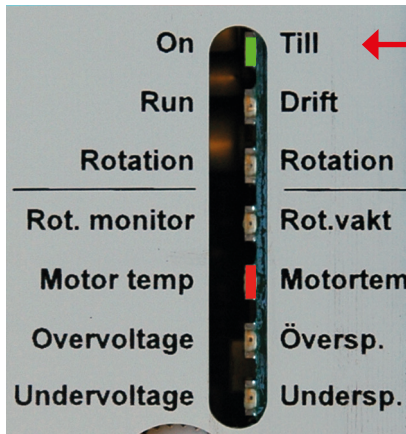

Probable cause:

The rotor is heavy to run.

The gear is jammed, no oil.

Motor/gear is broken, e.g. bearing fault.

The thermal contact in the motor will revert to the default position when the temperature drops, but the alarm will remain in state and must be reset on the control unit.

If the control unit trips when the motor is cold, disconnect the cables to the thermal contact (T-T). Jump the terminals T-T and reset the control unit with the reset button.

If the alarm persists, the control unit is defective.

If the alarm is cancelled, the fault is in the motor or the wiring.

Overvoltage

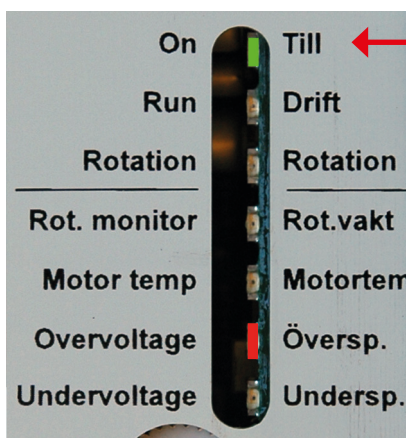

Probable cause:

The power supply exceeds 276 V for more than 4-5 seconds, after which the control unit trips. Check the power supply.

If the voltage is correct, the control unit is defective.

Undervoltage

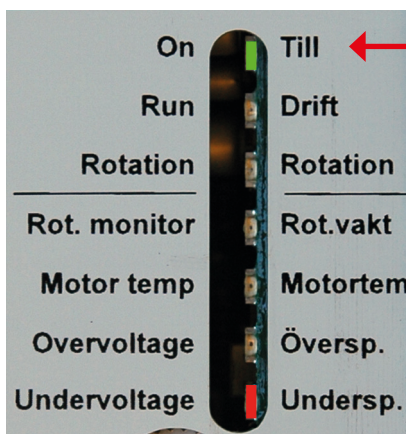

Probable cause:

The power supply is below 195 V for more than 4-5 seconds, after which the control unit trips. Check the power supply.

If the voltage is correct, the control unit is defective.

Overcurrent, Short circuit

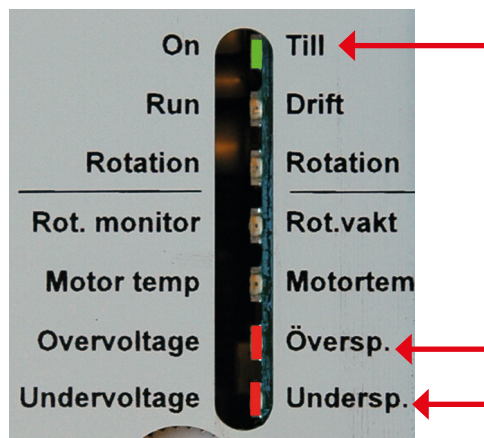

When both the Overvoltage and Undervoltage indicators are lit, it indicates overvoltage or a short-circuit.

Overcurrent The control unit limits current and trips after 4-5 seconds. Probable cause:

- The rotor is heavy to run.
- The gear is jammed, no oil.
- Motor/gear is broken, e.g. bearing fault.
- The control unit is broken.

Measure amperage:
MicroMax limits current to 1.2 A.
MicroMax180 limits current to 2.4 A.
MicroMax370 limits current to 4 A.
MicroMax750 limits current to 7 A.

If a small 25-40 W motor is used, the control unit will not trip for overcurrent as the current is below the limit even with a stationary motor shaft. This means the control unit will trip after 5-6 minutes via the rotation sensor. The control unit may also trip via the temperature switch if the motor overheats.

Phase-to-phase short circuit: The control unit limits current and trips after 4-5 seconds. Probable cause:

- Motor winding fault.
- Phase-to-phase short circuit in the cable.
- Measure motor resistance; it should be identical on all phases. (See page 8).

Phase-to-earth short circuit (earth fault). The control unit trips immediately. Probable cause:

- Earth fault in motor or cable.
- Cable caught between cover and terminal box frame.
- Measure resistance between phase and earth. It should be infinite.

NOTE: In the event of an earth fault, the control unit must be reset with power off.

In practice, it can be difficult to differentiate between the above faults. Another method is as follows:

- Reset the control unit.
- If the control unit alarms after resetting, switch off the power supply to the control unit, disconnect the motor cables (U, V, W) from the control unit and test it without the motor.
- If the alarm recurs, the control unit is defective; if the alarm disappears, continued troubleshooting as described above.

No LED lit

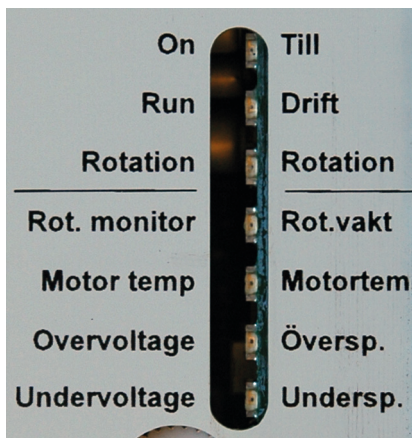

Probable cause:

Measure the power supply on terminals L and N; should be 230 V.

If the voltage is as above, check the fuse in the control unit.

If the fuse is intact, the control unit is defective.

The wheel rotates despite a 0% input signal from the control unit

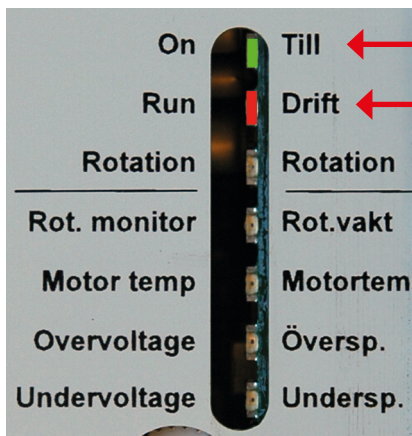

Probable cause:

In certain cases the control unit may give residual voltage even though it should be at 0.0 V.

Measure the voltage across terminals 2-3; it should be below 0.07 V for the control unit to switch off.

Check that the High Speed and Low Speed DIP switches are set to OFF.

If the input signal exceeds the above value, first check that the control unit settings are correct.

Alternatively, a supplementary input signal amplification card may be used (article number F29315101) to remedy the fault.



Connecting and troubleshooting VVX motors

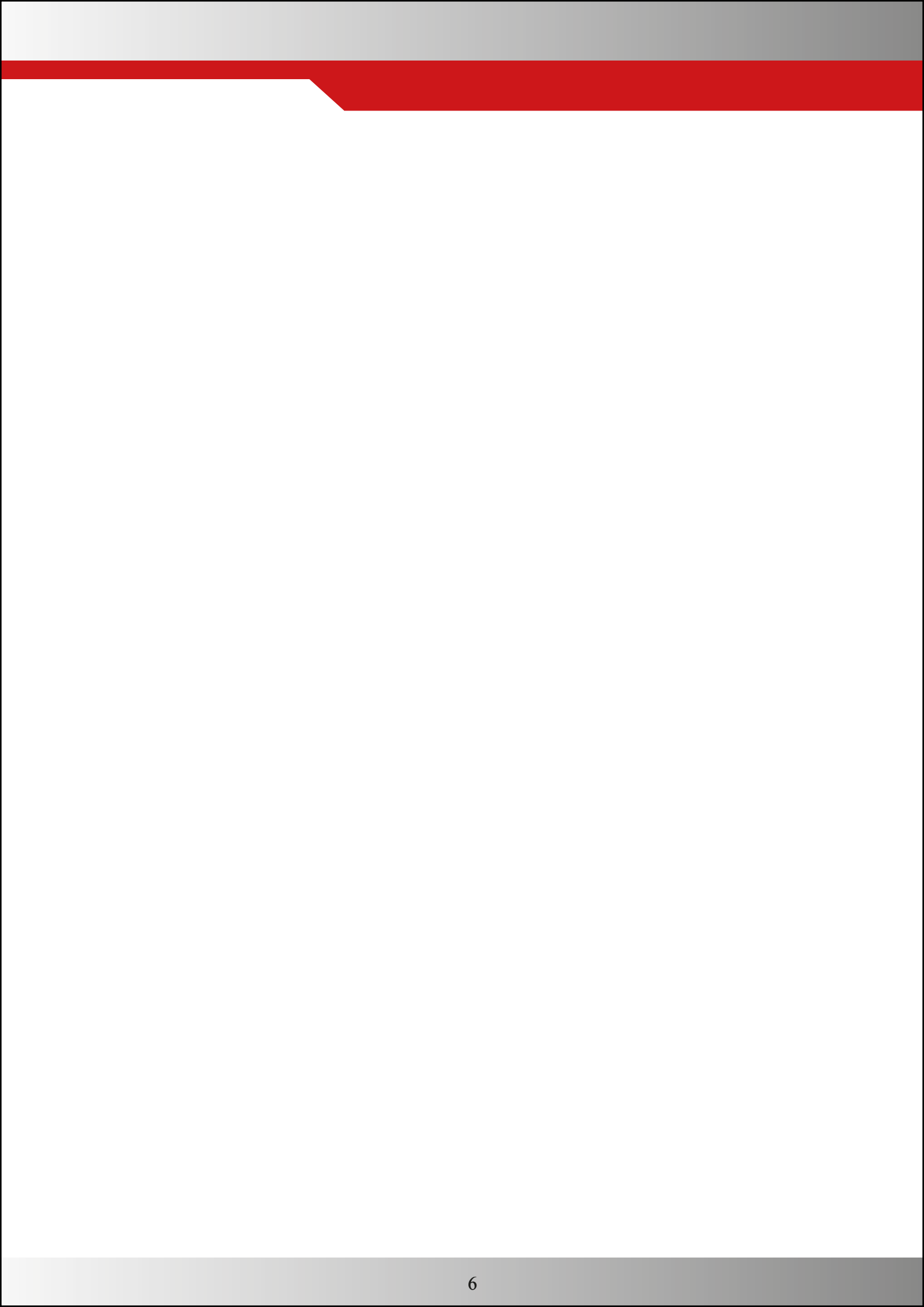

Connecting and troubleshooting VVX motors

All IBC control units have a 1x230 V single phase power supply. Because the control unit builds up 3x230 V phases, all VVX motors controlled by MiniMax and MicroMax three-phase motors are wired for 3x230 V.

Connecting a three-phase geared motor

Temperature switch (T – T)

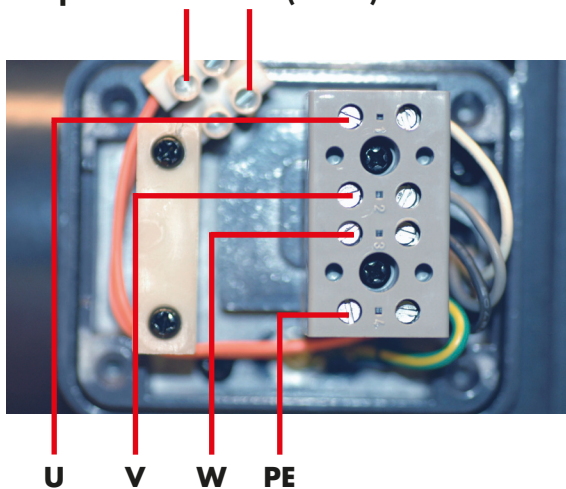

VVX motors with outputs of 25, 40 and 60 W are geared motors designed for 3x230 V. They cannot be rewired for 3x400V.

Connecting a three-phase worm gear motor

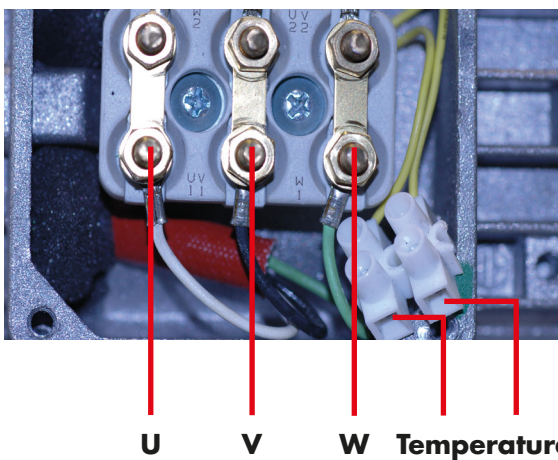

VVX motors with outputs of 90, 180, 370 and 750 W are worm gear motors designed for 3x230/400 V (Star/Delta).

On delivery from IBC, the motors are Delta wired, i.e. wired for 3x230 V. This is often referred to as 111 wiring as the three connections resemble three numeral 1s side by side.

All of the motors have temperature switches wired to a terminal block for onward connection to the control unit. Note that it is the control unit that cuts power via the temperature switch if the motor overheats.

Connecting a single-phase worm gear motor

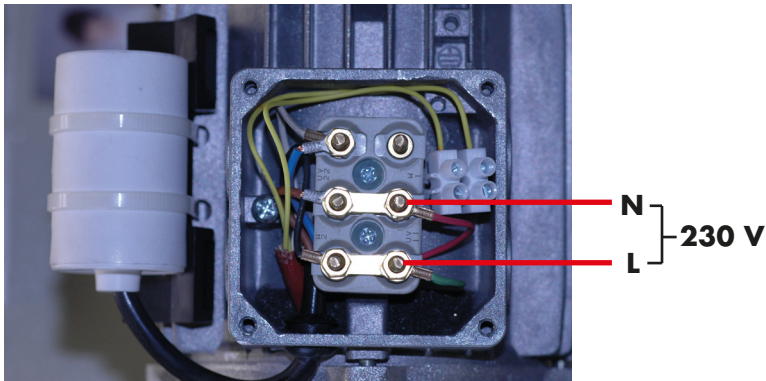

Motors controlled by MicroStart are single-phase motors wired for 1x230 V. An operating capacitor is used to assist start. The capacitor is located either in the MicroStart control unit or the motor. Also refer to the MicroStart connection instructions.

In most cases there is also a temperature switch wired to a terminal block. *Not illustrated.*

Alternatively, a thermal circuit breaker aka a klixon is installed in the winding. This cuts power in the winding and the motor stops. When the motor cools, the circuit is closed again.

In this case, the control unit will not give an overheating alarm, but the rotation sensor will give an alarm.

Connecting a three-phase GEFEG motor

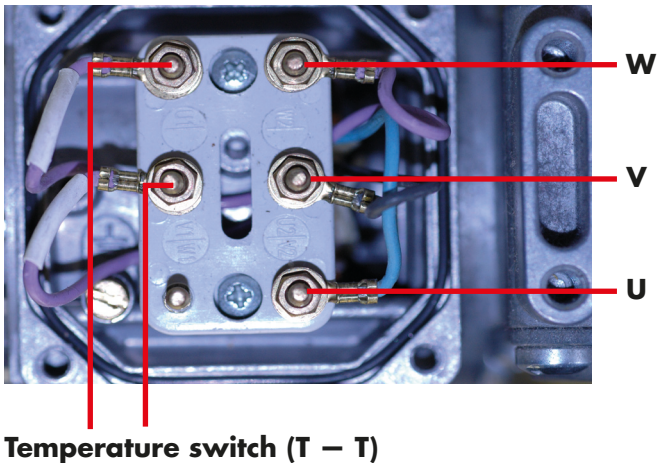

Previously, IBC used three-phase motors made by Gefeg. These motors are wired as illustrated on the left.

It is unclear how a replacement motor if any will be wired; refer to the wiring alternatives above.

Measuring motor winding resistance

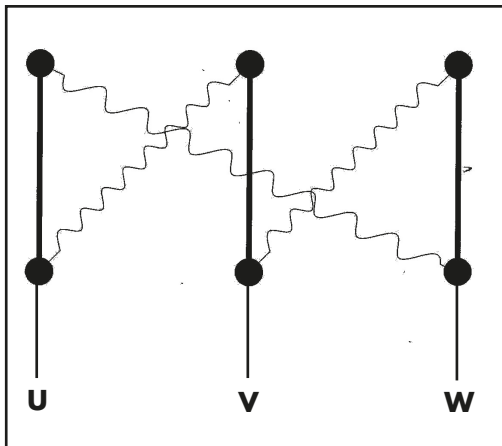

Tests should be performed using a Megger or a universal instrument to make sure that the motor windings are intact.

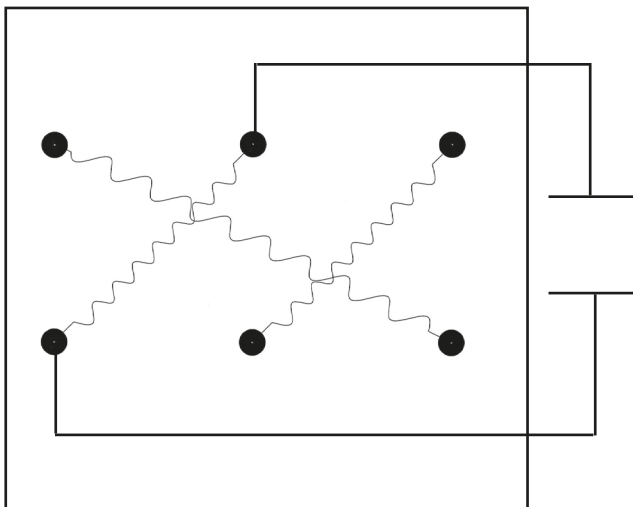

Measuring resistance

Before the test is carried out, the motor cables must be disconnected and the connection links in the motor removed.

Resistance should be identical on all three phases.

Your notes

A large area for taking notes, consisting of 20 horizontal lines alternating between light gray and white. The lines are evenly spaced and cover most of the page's width and height.

Your notes

A series of horizontal lines for writing notes, alternating between light gray and white. The lines are arranged in a repeating pattern of light gray, white, light gray, white, and light gray, starting and ending with a light gray line. There are 15 lines in total, providing a structured space for taking notes.

IBCcontrol

IBC control AB

Brännerigatan 5 A

SE-263 37 Höganäs

Sweden

Telephone +46 (0)42 33 00 10

Fax +46 (0)42 33 03 75

www.ibcccontrol.se

info@ibcccontrol.se